

HYVA CYLINDER

714 04 421



type: UMB 129-5-1480-K192-45-1/2"-HC

tipping weight: 6-17 ton

page # 1 / 2

Stage diameters 129 110 91 72 53	front view cylinder		<table border="1"> <tr><td>A</td><td>175</td></tr> <tr><td>ØC</td><td>150</td></tr> <tr><td>G¹</td><td>508</td></tr> <tr><td>I</td><td>316</td></tr> <tr><td>K¹</td><td>192</td></tr> <tr><td>M¹</td><td>86</td></tr> <tr><td>ØP</td><td>88</td></tr> <tr><td>ØQ</td><td>53</td></tr> <tr><td>S</td><td>325</td></tr> <tr><td>ØW</td><td>45</td></tr> <tr><td>X</td><td>45</td></tr> </table>	A	175	ØC	150	G¹	508	I	316	K¹	192	M¹	86	ØP	88	ØQ	53	S	325	ØW	45	X	45
A	175																								
ØC	150																								
G¹	508																								
I	316																								
K¹	192																								
M¹	86																								
ØP	88																								
ØQ	53																								
S	325																								
ØW	45																								
X	45																								

¹including 20 mm pull-out [tol. -5; +30 mm]

²cylinder is delivered including oil inlet swivel adapter and cup

specifications

total stroke ¹	1480 mm
dry weight cylinder only	57 kg
total volume	11.6 L
working volume	10.5 L
maximum pressure	220 bar
maximum pump flow	33 l/min
maximum allowable thrust first stage ³	15.0 ton
oil inlet	1/2" BSP

technical notes

This cylinder is a lifting device only and may not be used as a structural member or be subjected to side load. Sideload and/or poor alignment might result in cylinder leakage. Hyva therefore strongly recommends the use of a cradle, even in instances where the cylinder only tips to the rear or to the side. The cylinder is painted black RAL9005. For suitable hydraulic oils, please refer to data sheet OIL-0011. For details of available brackets and cradles, please refer data sheet 015BRA06.

Detailed calculations can be made using the HYVA Tipper Program, freely available from tipper.hyva.com.

³The cylinder thrust on the first stage (from the HYVA Tipper Program) must not exceed the maximum allowable (see specifications above).

tipping view

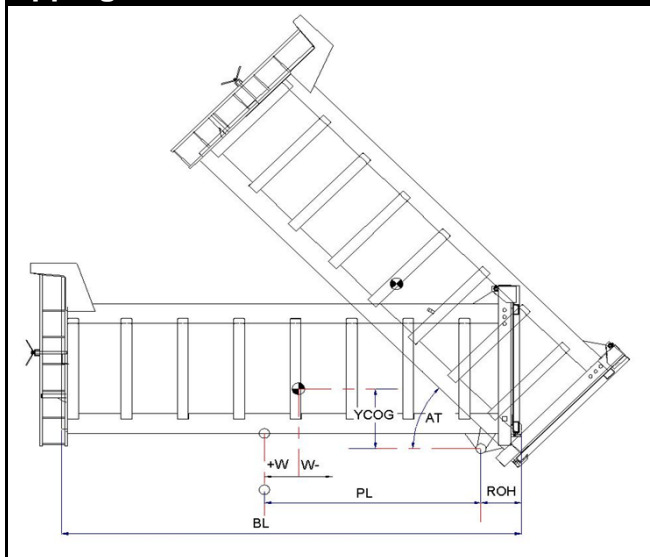

tipping weight

PL	1930			mm	1710		
YCOG	500			mm	500		
ROH	500			mm	500		
BL	5400	4860	4420	mm	4910	4420	4020
CYL w.r.t. COG (W)	-270	0	220	mm	-250	0	200
	Tipping weight for full stroke of 46°				Tipping weight for full stroke of 52°		
Tipping weight	6	7	8	ton	7	8	9
	Tipping weight for second last stage, up to 37°				Tipping weight for 2nd last stage, up to 42°		
Tipping weight	10	13	15	ton	11	15	17

HYVA CYLINDER

714 04 421

type

UMB 129-5-1480-K192-45-1/2"-HC

page # 2 / 2

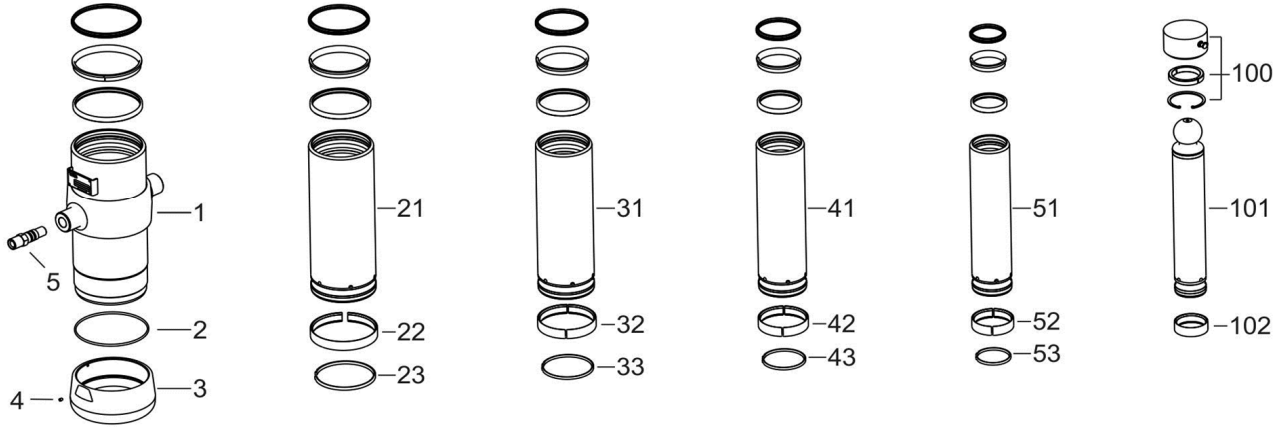

Spare part list

Pos	Part no.	Description	Qty.
1	73505300	BASE 149-0398-N0106	1
2	01226680	O-RING 145 X 4 70 SHORE	1
3	73101030	THREADED BOTTOM UM 149	1
4	01792571	LOCKING SCREW M6X12 INT. HEX. DIN 916	1
5	73103000	OIL INLET ADAPTOR UM 1/2"OT+O-RING	1
21	73604301	STAGE 129-0398-HC	1
22	71807129 K	SLIDER FL 129/GF 129 (2 X 1/2)	1
23	71812129 K	LIFTRING FL 129/HP 129	1
31	73603301	STAGE 110-0398-HC	1
32	71807110 K	SLIDER FL 110/GF 110 (2 X 1/2)	1
33	71812110 K	LIFTRING FL 110	1
41	73602301	STAGE 091-0398-HC	1
42	71807091 K	SLIDER FL 091 (2 X 1/2)	1
43	71812091 K	LIFTRING FL 091	1
51	73601301	STAGE 072-0398-HC	1
52	71807072 K	SLIDER FL 072 (2 X 1/2)	1
53	71810072 K	INNER STOPRING/LIFTRING FL 072	1

Spare part list

Pos	Part no.	Description	Qty.
100	01745101	RETAINER KIT UMB D.53	1
101	73400301	PISTON B 053-0434-HC	1
102	71807053 K	SLIDER FL 053 (2 X 1/2)	1

Seal kit complete

Part no.	Description
719 04 450K	Complete packset: Consists of all packsets with packset grease and o-ring.